

# studio

## SETUP GUIDE



YOURS IS HERE



# studio

## SETUP GUIDE

Regulatory Model P03G series

Regulatory Type P03G001

# Notes, Cautions, and Warnings

 **NOTE:** A NOTE indicates important information that helps you make better use of your computer.

 **CAUTION:** A CAUTION indicates either potential damage to hardware or loss of data and tells you how to avoid the problem.

 **WARNING:** A WARNING indicates a potential for property damage, personal injury, or death.

If you purchased a Dell™ n Series computer, any references in this document to Microsoft® Windows® operating systems are not applicable.

---

**Information in this document is subject to change without notice.**

© 2009 Dell Inc. All rights reserved.

Reproduction of these materials in any manner whatsoever without the written permission of Dell Inc. is strictly forbidden.

Trademarks used in this text: *Dell*, the *DELL* logo, *YOURS IS HERE*, and *DellConnect* are trademarks of Dell Inc.; *Intel* is a registered trademark and *Core* is a trademark of Intel Corporation in the U.S. and other countries; *Microsoft*, *Windows*, *Windows Vista*, and *Windows Vista* start button logo are either trademarks or registered trademarks of Microsoft Corporation in the United States and/or other countries; *Bluetooth* is a registered trademark owned by Bluetooth SIG, Inc. and is used by Dell under license; *SRS Premium Sound*, *SRS*, and the  symbol are trademarks of SRS Labs, Inc.

Other trademarks and trade names may be used in this document to refer to either the entities claiming the marks and names or their products. Dell Inc. disclaims any proprietary interest in trademarks and trade names other than its own.

**October 2009**

**P/N KWJH0**

**Rev. A01**

# Contents

<b>Setting Up Your Studio Laptop</b> . . . . .	<b>5</b>	Removing and Replacing the Battery . . . . .	36
Before Setting Up Your Computer . . . . .	5	Using the Optical Drive . . . . .	38
Connect the AC Adapter . . . . .	6	Software Features . . . . .	39
Connect the Network Cable (Optional) . . . . .	7	Free Fall Sensor . . . . .	42
Press the Power Button . . . . .	8	Dell Dock . . . . .	43
Set Up Microsoft Windows . . . . .	9	<b>Solving Problems</b> . . . . .	<b>44</b>
Install the SIM Card (Optional) . . . . .	10	Beep Codes . . . . .	44
Enable or Disable Wireless (Optional) . . . . .	12	Network Problems . . . . .	45
Connect to the Internet (Optional) . . . . .	14	Power Problems . . . . .	46
<b>Using Your Studio Laptop</b> . . . . .	<b>18</b>	Memory Problems . . . . .	47
Right Side Features . . . . .	18	Lockups and Software Problems . . . . .	48
Left Side Features . . . . .	22	<b>Using Support Tools</b> . . . . .	<b>50</b>
Computer Base and Keyboard Features . . . . .	26	Dell Support Center . . . . .	50
Touch Pad Gestures . . . . .	28	System Messages . . . . .	51
Multimedia Control Keys . . . . .	32	Hardware Troubleshooter . . . . .	53
Display Features . . . . .	34	Dell Diagnostics . . . . .	54

## Contents

<b>Restoring Your Operating System</b> .....	<b>58</b>	<b>Finding More Information and Resources</b> .....	<b>72</b>
System Restore .....	59	<b>Specifications</b> .....	<b>74</b>
Dell DataSafe Local Backup .....	60	<b>Appendix</b> .....	<b>87</b>
Operating System Reinstallation .....	62	Information for NOM, or Official Mexican Standard (only for Mexico).....	87
<b>Getting Help</b> .....	<b>64</b>	<b>Index</b> .....	<b>88</b>
Technical Support and Customer Service .....	65		
DellConnect .....	65		
Online Services .....	66		
Automated Order-Status Service.....	67		
Product Information.....	67		
Returning Items for Repair Under Warranty or for Credit.....	68		
Before You Call.....	69		
Contacting Dell.....	71		

# Setting Up Your Studio Laptop

This section provides information about setting up your Studio laptop.

## Before Setting Up Your Computer

When positioning your computer, ensure that you allow easy access to a power source, adequate ventilation, and a level surface to place your computer.

Restricting airflow around your Studio laptop may cause it to overheat. To prevent overheating ensure that you leave at least 10.2 cm (4 inches) at the back of the computer and a minimum of 5.1 cm (2 inches) on all other sides. You should never place your computer in an enclosed space, such as a cabinet or drawer when it is powered on.

 **WARNING:** Do not block, push objects into, or allow dust to accumulate in the air vents. Do not store your Dell™ computer in a low-airflow environment, such as a closed briefcase, while it is powered on. Restricting the airflow can damage the computer or cause a fire. The computer turns on the fan when the computer gets hot. Fan noise is normal and does not indicate a problem with the fan or the computer.

 **CAUTION:** Placing or stacking heavy or sharp objects on the computer may result in permanent damage to the computer.

## Connect the AC Adapter

Connect the AC adapter to the computer and then plug it into an electrical outlet or surge protector.

**⚠ WARNING:** The AC adapter works with electrical outlets worldwide. However, power connectors and power strips vary among countries. Using an incompatible cable or improperly connecting the cable to a power strip or electrical outlet may cause fire or permanent damage to your computer.

**📎 NOTE:** Use only Dell AC adapter family PA-10, PA-2E, PA-3E, or PA-12 with your computer. For more information, see “Specifications” on page 74, or the system regulatory label on the bottom of your computer.

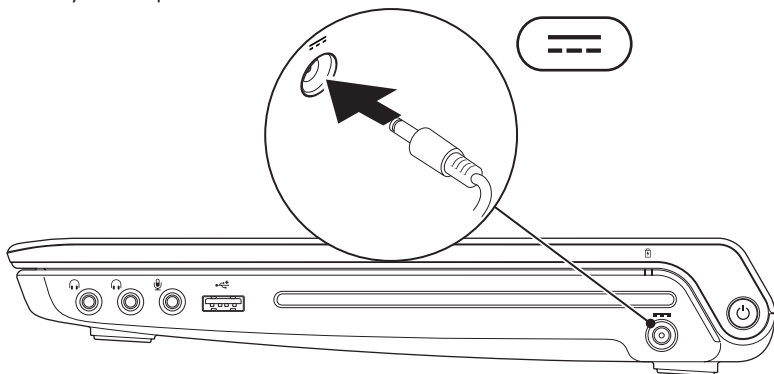



## Connect the Network Cable (Optional)

To use a wired network connection, connect the network cable.

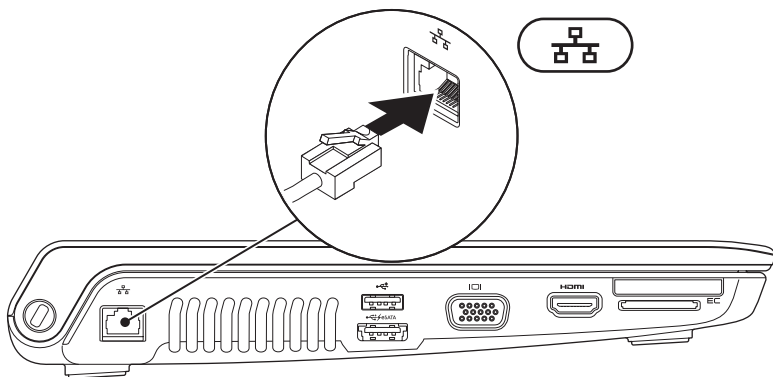

## Press the Power Button

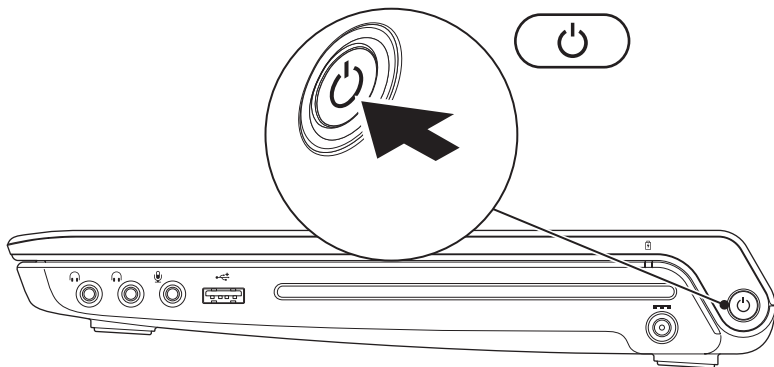

## Set Up Microsoft Windows

Your Dell computer is preconfigured with Microsoft® Windows® operating system. To set up Windows for the first time, follow the instructions on the screen. These steps are mandatory and may take some time to complete. The Windows setup screen will take you through several procedures including accepting license agreements, setting preferences, and setting up an Internet connection.

 **CAUTION:** Do not interrupt the operating system's setup process. Doing so may render your computer unusable and you will need to reinstall the operating system.

 **NOTE:** For optimal performance of your computer, it is recommended that you download and install the latest BIOS and drivers for your computer available at [support.dell.com](http://support.dell.com).

### Install the SIM Card (Optional)

 **NOTE:** Installing a Subscriber Identity Module (SIM) card is not required if you are using an EVDO card to access the Internet.

Installing a SIM card allows you to connect to the Internet. To access the Internet you must be within the network of your cellular service provider.

To install the SIM:

1. Turn off your computer.
2. Remove the battery (see “Removing and Replacing the Battery” on page 36).
3. In the battery bay, slide the SIM card into the SIM card slot.
4. Replace the battery (see “Removing and Replacing the Battery” on page 36).
5. Turn on your computer.

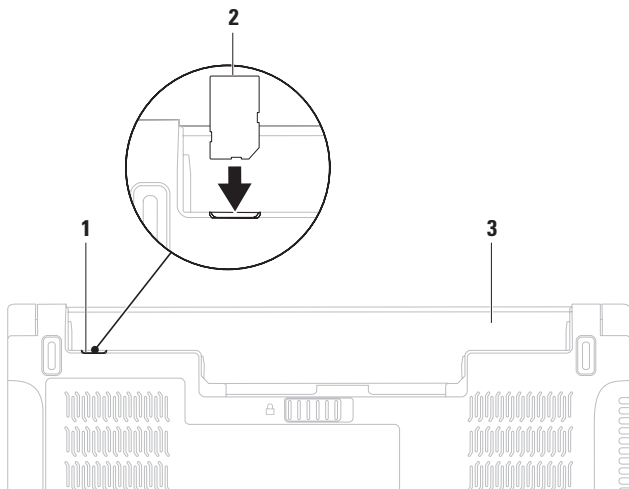

---

**1** SIM card slot

---

**2** SIM card

---

**3** battery bay

---

### Enable or Disable Wireless (Optional)

Press the  $\langle \text{A} \rangle$  key or press the  $\langle \text{Fn} \rangle \langle \text{F2} \rangle$  keys on the keyboard to enable or disable wireless. The wireless on or off icons appear on the screen to indicate the status.

 **NOTE:** The wireless feature is available on your computer only if you purchased a WLAN or a Bluetooth card.

Wireless on:



Wireless off:



For information on changing the behavior of the Fn key, see “Multimedia Control Keys” on page 32.

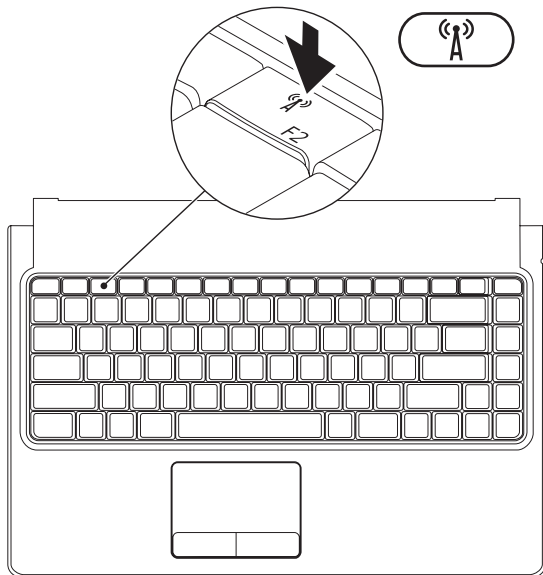

## Connect to the Internet (Optional)

To connect to the Internet, you need an external modem or network connection and an Internet Service Provider (ISP).

If an external USB modem or WLAN adapter is not a part of your original order, you can purchase one at [www.dell.com](http://www.dell.com).

## Setting Up a Wired Connection

- If you are using a dial-up connection, connect the telephone line to the external USB modem (optional) and to the telephone wall connector before you set up your Internet connection.
- If you are using a DSL or cable/satellite modem connection, contact your ISP or cellular telephone service for setup instructions.

To complete setting up your wired internet connection, follow the instructions in “Setting Up Your Internet Connection” on page 16.



## Setting Up a Wireless Connection

 **NOTE:** To set up your wireless router, see the documentation that shipped with your router.

Before you can use your wireless Internet connection, you need to connect to your wireless router.

To setup your connection to a wireless router:

### *Windows Vista®*

1. Ensure that wireless is enabled on your computer (see “Enable or Disable Wireless” on page 12).
2. Save and close any open files, and exit any open programs.
3. Click **Start**  → **Connect To**.
4. Follow the instructions on the screen to complete the setup.

### *Windows® 7*

1. Ensure that wireless is enabled on your computer (see “Enable or Disable Wireless” on page 12).
2. Save and close any open files, and exit any open programs.
3. Click **Start**  → **Control Panel** → **Network and Sharing Center** → **Connect to a network**.
4. Follow the instructions on the screen to complete the setup.

### Setting Up Your Internet Connection

ISPs and ISP offerings vary by country. Contact your ISP for offerings available in your country.

If you cannot connect to the Internet but have successfully connected in the past, the ISP might have a service outage. Contact your ISP to check the service status, or try connecting again later.

Have your ISP information ready. If you do not have an ISP, the **Connect to the Internet** wizard can help you get one.

To set up your Internet connection:

*Windows Vista*<sup>®</sup>

 **NOTE:** The following instructions are applicable for the Windows default view, so they may not apply if you set your Dell™ computer to the Windows Classic view.

1. Save and close any open files, and exit any open programs.
2. Click **Start**  → **Control Panel**.
3. Click **Network and Internet** → **Network and Sharing Center** → **Set up a connection or network** → **Connect to the Internet**.

The **Connect to the Internet** window appears.

 **NOTE:** If you do not know which type of connection to select, click **Help me choose** or contact your ISP.

4. Follow the instructions on the screen and use the setup information provided by your ISP to complete the setup.

*Windows® 7*

1. Save and close any open files, and exit any open programs.
2. Click **Start**  → **Control Panel**.
3. Click **Network and Sharing Center** → **Set up a new connection or network** → **Connect to the Internet**.

The **Connect to the Internet** window appears.

 **NOTE:** If you do not know which type of connection to select, click **Help me choose** or contact your ISP.



4. Follow the instructions on the screen and use the setup information provided by your ISP to complete the setup.

# Using Your Studio Laptop

This section provides information about the features available on your Studio laptop.

## Right Side Features





- 
-  **Audio out/Headphone connectors (2)** — Connects one or two pairs of headphones or sends audio to a powered speaker or sound system. The audio signal is the same for both connectors.
  -  **Audio in/Microphone connector** — Connects to a microphone or inputs signal for use with audio programs.
  -  **USB 2.0 connector** — Connects to USB devices, such as a mouse, keyboard, printer, external drive, or MP3 player.
- 

#### 4 Optical drive —

 **CAUTION: Do not use non-standard-size or shape discs (including mini-CDs and mini-DVDs) or you will damage the drive.**

Plays or records only standard-size (12 cm) CDs, DVDs, and Blu-ray Discs (optional). Ensure that the side with print or writing is facing upward when inserting discs. For more information, see “Using the Optical Drive ” on page 38.

---

- 5  **AC adapter connector** — Connects to the AC adapter to power the computer and charge the battery.
- 
- 6  **Power button and light** — Turns the computer on or off when pressed. The light in the button indicates the following power states:
- Solid white — The computer is on.
  - Blinking white — The computer is in standby mode.
  - Off — The computer is off.
-

- 7  **Battery status light** — Turns on steadily or blinks to indicate the battery charge status. The light indicates the following states when the computer is powered using either the AC adapter or the battery.

	<b>Indicator light status</b>	<b>Computer state(s)</b>	<b>Battery charge level</b>
<b>AC adapter</b>	solid white	on/off/hibernate/ standby	charging 10%–90%
	off	on/off/hibernate/ standby	>90%
	solid amber	on/off/hibernate/ standby	<10%
<b>Battery</b>	solid amber	on/standby	<10%
	off	on/off/hibernate/ standby	>10%

**NOTE:** The battery is charging when the computer is powered using the AC adapter.

## Left Side Features

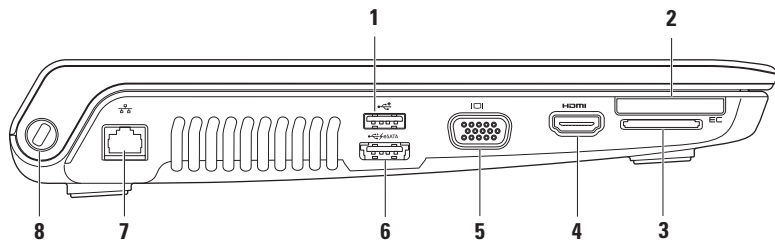



---

1  **USB 2.0 connector** — Connects to USB devices, such as a mouse, keyboard, printer, external drive, or MP3 player.

---

2  **ExpressCard slot** — Provides support for additional memory, wired and wireless communications, multimedia, and security features. The slot supports 34 mm ExpressCards.

**NOTE:** The ExpressCard slot is designed only for ExpressCards. The slot does NOT support PC cards.

**NOTE:** Your computer ships with a plastic blank installed in the ExpressCard slot. Blanks protect unused slots from dust and other particles. Save the blank for use when no ExpressCard is in the slot; blanks from other computers may not fit your computer.

---

3 **8-in-1 Media Card Reader** — Provides a fast and convenient way to view and share digital photos, music, videos, and documents stored on the following digital memory cards:

- Secure Digital (SD) memory card
- Secure Digital Input/Output (SDIO) card
- Secure Digital High Capacity (SDHC)
- Secure Digital High Density (SDHD)
- Memory Stick
- Memory Stick PRO
- MultiMedia Card (MMC)
- xD-Picture Card

**NOTE:** Your computer ships with a plastic blank installed in the media card slot. Blanks protect unused slots from dust and other particles. Save the blank for use when no media card is in the slot; blanks from other computers may not fit your computer.

---

- 4  **HDMI connector** — Connects to a TV for both 5.1 audio and video signals.

**NOTE:** When used with a monitor, only the video signal is read.

---

- 5  **VGA connector** — Connects video devices, such as a monitor or projector.
- 

- 6  **eSATA/USB combo connector with USB PowerShare** — Connects to eSATA compatible storage devices (such as external hard drives or optical drives) or USB devices (such as a mouse, keyboard, printer, external drive, or MP3 player).

The USB PowerShare feature allows you to charge USB devices when the computer is powered on/off or in sleep state.

**NOTE:** Certain USB devices may not charge when the computer is powered off or in sleep state. In such cases turn on the computer to charge the device.

**NOTE:** If you turn off your computer while charging a USB device, the device will stop charging. To continue charging, disconnect the USB device and connect it again.

**NOTE:** The USB PowerShare is automatically shut off when only 10% of the total battery life remains.

---

**7**  **Network connector** — Connects your computer to a network or a broadband device if you are using a wired network.

---

**8 Security cable slot** — Attaches a commercially available security cable to the computer.

**NOTE:** Before you buy a security cable, ensure that it works with the security cable slot on your computer.

---

## Computer Base and Keyboard Features

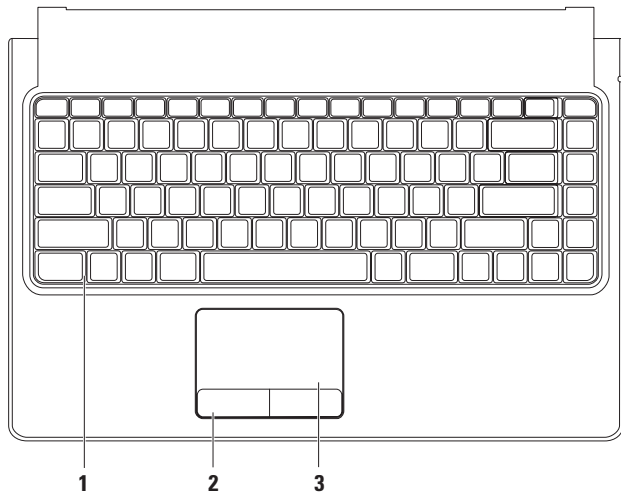

---

**1 Keyboard/Backlit keyboard (optional) —**

If you have purchased the optional backlit keyboard, the F6 key has the backlit keyboard icon  on it. The optional backlit keyboard provides visibility in dark environments by illuminating all symbols on the keys.

 **Backlit keyboard brightness settings** — Press the <F6> key to toggle the three lighting states (in the given order):

- a. half keyboard brightness
- b. full keyboard brightness
- c. no lighting

For more information on using the keyboard, see the *Dell Technology Guide*.

---

**2 Touch pad buttons** — Provide left- and right-click functions like those on a mouse.

---

**3 Touch pad** — Provides the functionality of a mouse to move the cursor, drag or move selected items, and left-click by tapping the surface.

The touch pad also supports scroll, zoom, and rotate features. To change the touch pad settings, double-click the **Synaptics Pointing Device** icon in the notification area of your desktop.

---

## Touch Pad Gestures

### One-Finger Gestures

**One-Finger Scrolling** — Allows you to scroll through content. The scroll feature includes:

**Traditional Scroll** — Allows you to scroll up or down, and right or left.

To scroll up or down:

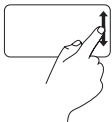

Move a finger up or down in the vertical scroll zone (extreme right of the touch pad).

To scroll right or left:

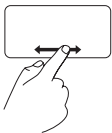

Move a finger right or left in the horizontal scroll zone (extreme bottom of the touch pad).

**Auto Scroll Vertical** — Allows you to continuously scroll up or down on the active window.

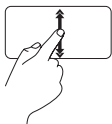

Move a finger up or down at a fast pace (from the center of the touch pad to the extreme edge) to trigger vertical auto scrolling.

Tap the touch pad to stop auto scrolling.

**Auto Scroll Horizontal** — Allows you to continuously scroll right or left on the active window.

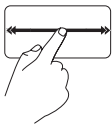

Move a finger right or left at a fast pace (from the center of the touch pad to the extreme edge) to trigger horizontal auto scrolling.

Tap the touch pad to stop auto scrolling.

**Circular Scroll** — Allows you to scroll up or down, and right or left.

Circular scroll is disabled by default. To enable this gesture, click **Start**  → **Control Panel** → **Mouse** → **Device Settings** → **Settings** → **Scrolling** → **One-Finger Scrolling** → **Enable Circular Scrolling**.

To scroll up or down:

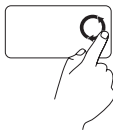

Move a finger in the vertical scroll zone (extreme right of the touch pad), in a clockwise circular motion to scroll up or counterclockwise circular motion to scroll down.

To scroll right or left:



Move a finger in the horizontal scroll zone (extreme bottom of the touch pad), in a clockwise circular motion to scroll right or counterclockwise circular motion to scroll left.

### Two-Finger Gestures

**Scroll** — Allows you to scroll through content.

The scroll feature includes:

**Auto Scroll Vertical** — Allows you to continuously scroll up or down on the active window.

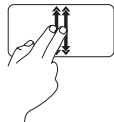

Move two fingers up or down at a fast pace (from the center of the touch pad to the extreme edge) to trigger vertical auto scrolling.

Tap the touch pad to stop auto scrolling.

**Auto Scroll Horizontal** — Allows you to continuously scroll right or left on the active window.

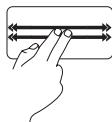

Move two fingers right or left at a fast pace (from the center of the touch pad to the extreme edge) to trigger horizontal auto scrolling.

Tap the touch pad to stop auto scrolling.



**Zoom** — Allows you to increase or decrease the magnification of the screen content. The zoom feature includes:

**Pinch** — Allows you to zoom in or zoom out by moving two fingers apart or bringing them closer together on the touch pad.

To zoom in:

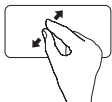

Move two fingers apart to zoom in on the active window.

To zoom out:

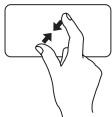

Move two fingers close together to zoom out on the active window.

**Rotate** — Allows you to rotate the active content on the screen. The rotate feature includes:

**Twist** — Allows you to rotate the active content in 90 degree increments using two fingers where one finger is anchored and the other rotates.



Keeping the thumb in place, move the index finger in an arced direction right or left to rotate the selected item 90 degrees clockwise or counterclockwise.

# Multimedia Control Keys

The multimedia controls can be accessed using the multimedia control keys on the keyboard.

To use the multimedia controls, press the required key. You can configure the multimedia control keys using the **System Setup (BIOS) Utility** or the **Windows Mobility Center**.

## System Setup (BIOS) Utility

1. Press <F2> during POST (Power On Self Test) to enter the System Setup (BIOS) utility.
2. In the **Function Key Behavior**, select **Multimedia Key First** or **Function Key First**.

**Multimedia Key First** — This is the default option. Press any multimedia key to perform the associated action. For function key, press <Fn> + the required function key.

**Function Key First** — Press any function key to perform the associated action. For multimedia key, press <Fn> + the required multimedia key.

 **NOTE: Multimedia Key First** option is active only in the operating system.

## Windows Mobility Center

1. Press < > <X> to launch the Windows Mobility Center.
2. In the **Function Key Row**, select **Function Key** or **Multimedia Key**.



---

 Mute the sound

---

 Decrease the volume level

---

 Increase the volume level

---

 Play the previous track or chapter

---

---

 Play or pause

---

 Play the next track or chapter

---

 Eject the disc

---

## Display Features

The display panel holds a camera and accompanying dual microphones.

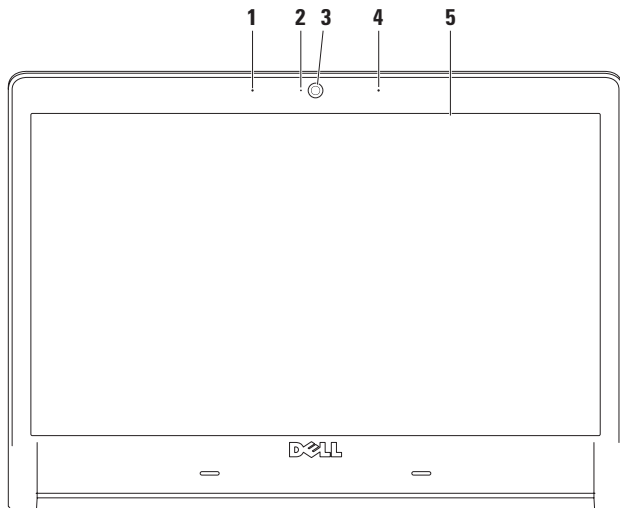

- 
- 1 Left digital array microphone** — Combines with the right digital array microphone to provide high quality sound for video chatting and voice recording.

---

  - 2 Camera activity light** — Indicates if the camera is on or off.

---

  - 3 Camera** — Built-in camera for video capture, conferencing, and chat.

---

  - 4 Right digital array microphone** — Combines with the left digital array microphone to provide high quality sound for video chatting and voice recording.

---

  - 5 Display** — Your display can vary based on selections you made when purchasing your computer. For more information about displays, see the *Dell Technology Guide*.
-

## Removing and Replacing the Battery

 **WARNING:** Using an incompatible battery may increase the risk of fire or explosion. This computer should only use a battery purchased from Dell. Do not use batteries from other computers.

 **WARNING:** Before removing the battery, shut down the computer, and remove external cables (including the AC adapter).

To remove the battery:

1. Shut down the computer and turn it over.
2. Slide the battery release latch to the side.
3. Slide the battery out of the battery bay.

To replace the battery:

Slide the battery into the battery bay until it clicks into place.

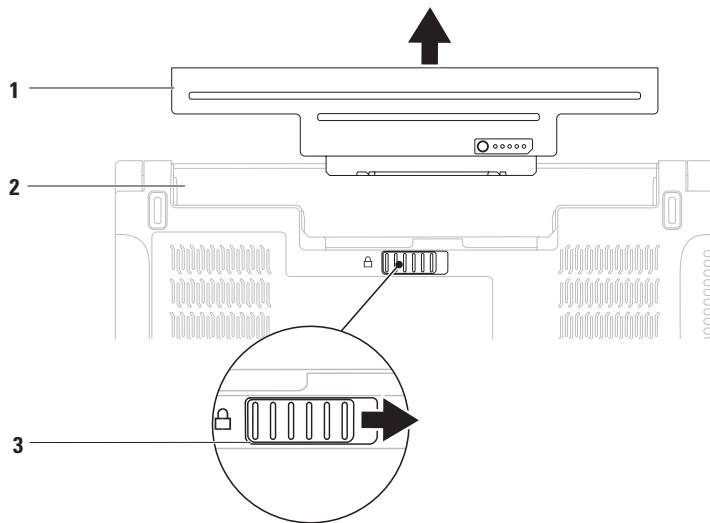

---

**1** battery

---

**2** battery bay

---

**3** battery release latch

---

## Using the Optical Drive

**△ CAUTION:** Do not use non-standard-size or shape discs (including mini-CDs and mini-DVDs) or you will damage the drive.

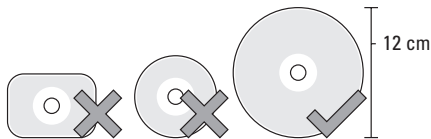

**✎ NOTE:** Do not move the computer while playing or recording CDs, DVDs, and Blu-ray Discs (optional).

Place the disc in the center of the disc slot, with the label facing upwards and gently push the disc into the slot. The drive will automatically pull the disc in and begin reading its content.

To eject a disc from the drive, press the eject key  on the keyboard (see “Multimedia Control Keys” on page 32).



## Software Features

 **NOTE:** For more information about the features described in this section, see the *Dell Technology Guide* available on your hard drive or at [support.dell.com](http://support.dell.com).

### FastAccess Facial Recognition

Your computer may have the FastAccess facial recognition feature. This feature helps keep your Dell computer secure by using the unique appearance of your face to verify your identity and automatically supply login information that you would normally enter manually, such as a user ID and password for a Windows account or secure web site.

For more information, click

**Start**  → **Programs** → **FastAccess**.

### Productivity and Communication

You can use your computer to create presentations, brochures, greeting cards, fliers, and spreadsheets. You can also edit and view

digital photographs and images. Check your purchase order for software installed on your computer.

After connecting to the Internet, you can access websites, setup an e-mail account, and upload or download files.

### Entertainment and Multimedia

You can use your computer to watch videos, play games, create your own CDs/DVDs, listen to music and Internet radio stations.

You can download or copy pictures and video files from portable devices, such as digital cameras and cell phones. Optional software applications enable you to organize and create music and video files that can be recorded to disc, saved on portable products such as MP3 players and handheld entertainment devices, or played and viewed directly on connected TVs, projectors, and home theater equipment.

### Customizing the Desktop

You can customize your desktop to change the appearance, resolution, wallpaper, screensaver, or other features of your desktop.

*Windows Vista®*

1. Right-click an open area of the desktop.
2. Click **Personalize**, to open the **Personalize appearance and sounds** window and learn more about your customization options.

*Windows® 7*

1. Right-click an open area of the desktop.
2. Click **Personalize**, to open the **Change the visuals and sounds on your computer** window and learn more about your customization options.

### Customizing Your Energy Settings

You can use the power options in your operating system to configure the power settings on your computer. The Microsoft® Windows® operating system installed with your Dell computer provides the following default options:

*Windows Vista®*

- **Dell Recommended** — Offers full performance when you need it and saves power during periods of inactivity.
- **Power saver** — Saves power on your computer by reducing system performance to maximize the life of the computer and by reducing the amount of energy consumed by your computer over its lifetime.
- **High performance** — Provides the highest level of system performance on your computer by adapting processor speed to your activity and by maximizing system performance.

*Windows® 7*

- **Dell** — Recommended default power plan with Dell enhancements. Offers full performance when you need it and saves power during periods of inactivity.
- **Power saver** — Saves power on your computer by reducing system performance to maximize the life of the computer and by reducing the amount of energy consumed by your computer over its lifetime.
- **Balanced** — Offers full performance when you need it and saves power during periods of inactivity.
- **High performance** — Provides the highest level of system performance on your computer by adapting processor speed to your activity and by maximizing system performance.

**Transferring Information to a New Computer**

To transfer information to a new computer:

*Windows Vista®*

 **NOTE:** The following instructions are applicable for the Windows default view, so they may not apply if you set your Dell™ computer to the Windows Classic view.

1. Click **Start**  → **Control Panel** → **System and Maintenance** → **Welcome Center** → **Transfer files and settings**.

If the **User Account Control** window appears, click **Continue**.

2. Follow the instructions on the **Windows Easy Transfer** wizard.

*Windows® 7*

1. Click **Start**  → **Control Panel**.
2. In the search box, type **Transfer** and then click **Transfer files from another computer**.
3. Follow the instructions on the **Windows Easy Transfer** wizard.

### Backing Up Your Data

It is recommended that you periodically back up files and folders on your computer.

To back up files:

*Windows Vista®*

1. Click **Start**  → **Control Panel** → **System and Maintenance** → **Back Up and Restore Center** → **Back up files**.

If the **User Account Control** window appears, click **Continue**.

 **NOTE:** Certain editions of Windows Vista provide an option to back up your computer.

2. Follow the instructions on the **Back Up Files** wizard.

*Windows® 7*

1. Click **Start**  → **Control Panel** → **System and Security** → **Backup and Restore**.
2. Click **Set up backup....**
3. Follow the instructions on the **Configure Backup** wizard.

### Free Fall Sensor

Free fall sensor protects your computer hard drive from possible damage, by detecting a free fall state caused by accidentally dropping the computer. When a free fall state is detected, the hard drive is placed in a *safe state* to protect against damage to the read/write head and possible data loss. Your hard drive returns to normal operation, when the free fall state is no longer detected.

## Dell Dock

The Dell Dock is a group of icons that provides easy access to frequently-used applications, files, and folders. You can personalize the Dock by:

- Adding or removing icons
- Changing the color and location of the Dock
- Grouping related icons into categories
- Changing the behavior of the icons



### Add a Category

1. Right-click the Dock, click **Add** → **Category**. The **Add/Edit Category** window is displayed.
2. Enter a title for the category in the **Title** field.
3. Select an icon for the category from the **Select an image:** box.
4. Click **Save**.

### Add an Icon

Drag and drop the icon to the Dock or a category.

### Remove a Category or Icon

1. Right-click the category or icon on the Dock and click **Delete shortcut** or **Delete category**.
2. Follow the instructions on the screen.

### Personalize the Dock

1. Right-click the Dock and click **Advanced Setting...**
2. Choose the desired option to personalize the Dock.

# Solving Problems

This section provides troubleshooting information for your computer. If you cannot solve your problem using the following guidelines, see “Using Support Tools” on page 50 or “Contacting Dell” on page 71.



**WARNING:** Only trained service personnel should remove the computer cover. See the *Service Manual* at [support.dell.com](http://support.dell.com) for advanced service and troubleshooting instructions.



**NOTE:** To replace parts, see the *Service Manual* at [support.dell.com](http://support.dell.com).

## Beep Codes

Your computer might emit a series of beeps during start-up if there are errors or problems. The series of beeps, called a beep code, identifies a problem. Write down the beep code and contact Dell (see “Contacting Dell” on page 71).

Beep Code	Possible Problem
One	Possible motherboard failure - BIOS ROM checksum failure
Two	No RAM detected <b>NOTE:</b> If you installed or replaced the memory module, ensure that the memory module is seated properly.
Three	Possible motherboard failure - Chipset error
Four	RAM read/write failure
Five	Real Time Clock failure
Six	Video card or chip failure
Seven	Processor failure
Eight	Display failure

## Network Problems

### Wireless Connections

**If the wireless network connection is lost** — The wireless router is offline or wireless has been disabled on the computer.

- Check your wireless router to ensure it is powered on and connected to your data source (cable modem or network hub).
- Ensure that wireless is enabled (see “Enable or Disable Wireless” on page 12).
- Re-establish your connection to the wireless router (see “Setting Up a Wireless Connection” on page 15).
- Interference may be blocking or interrupting your wireless connection. Try moving the computer closer to your wireless router.

### Wired Connections

**If the network connection is lost** — The cable is loose or damaged.

- Check the cable to ensure it is plugged in and not damaged.

# Power Problems

**If the power light is off** — The computer is either turned off or is not receiving power.

- Reseat the power cable into the power connector on the computer and the electrical outlet.
- If the computer is plugged into a power strip, ensure that the power strip is plugged into an electrical outlet and that the power strip is turned on. Also bypass power protection devices, power strips, and power extension cables to verify that the computer turns on properly.
- Ensure that the electrical outlet is working by testing it with another device, such as a lamp.
- Check the AC adapter cable connections. If the AC adapter has a light, ensure that the light on the AC adapter is on.

**If the power light is solid white and the computer is not responding** — The display may not be responding. Press the power button until the computer turns off and then turn it back on.

**If the power light is blinking white** — The computer is in standby mode. Move the mouse or press the power button to resume normal operation.

**If you encounter interference that hinders reception on your computer** — An unwanted signal is creating interference by interrupting or blocking other signals. Some possible causes of interference are:

- Power, keyboard, and mouse extension cables.
- Too many devices connected to a power strip.
- Multiple power strips connected to the same electrical outlet.



## Memory Problems

### If you receive an insufficient memory message —

- Save and close any open files and exit any open programs you are not using to see if that resolves the problem.
- See the software documentation for minimum memory requirements. If necessary, install additional memory (see the *Service Manual* at [support.dell.com](http://support.dell.com)).
- Reseat the memory modules (see the *Service Manual* at [support.dell.com](http://support.dell.com)) to ensure that your computer is successfully communicating with the memory.
- If the problem persists, contact Dell (see “Contacting Dell” on page 71).

### If you experience other memory problems —

- Run the Dell Diagnostics (see “Dell Diagnostics” on page 54).
- If the problem persists, contact Dell (see “Contacting Dell” on page 71).

## Lockups and Software Problems

**If the computer does not start up** — Ensure that the power cable is firmly connected to the computer and to the electrical outlet.

**If a program stops responding** —

End the program:

1. Press <Ctrl><Shift><Esc> simultaneously.
2. Click **Applications**.
3. Click the program that is no longer responding
4. Click **End Task**.

**If a program crashes repeatedly** — Check the software documentation. If necessary, uninstall and then reinstall the program.

 **NOTE:** Software usually includes installation instructions in its documentation or on the CD.

**If the computer stops responding or a solid blue screen appears** —



**WARNING:** You might lose data if you are unable to perform an operating system shutdown.

If you are unable to get a response by pressing a key on your keyboard or moving your mouse, press the power button for at least 8 to 10 seconds until the computer turns off and then restart your computer.

**If a program is designed for an earlier Microsoft® Windows® operating system** —

Run the Program Compatibility Wizard. The Program Compatibility Wizard configures a program so that it runs in an environment similar to an earlier version of Microsoft Windows operating system environments.

*Windows Vista®*

1. Click **Start**  → **Control Panel** → **Programs** → **Use an older program with this version of Windows.**
2. In the welcome screen, click **Next**.
3. Follow the instructions on the screen.

*Windows® 7*

1. Click **Start** .
2. In the search box, type `Use an older program with this version of Windows` and press `<Enter>`.
3. Follow the instructions on the **Program Compatibility** wizard.

**If you have other software problems —**

- Back up your files immediately.
  - Use a virus-scanning program to check the hard drive or CDs.
  - Save and close any open files or programs and shut down your computer through the **Start**  menu.
- Check the software documentation or contact the software manufacturer for troubleshooting information:
    - Ensure that the program is compatible with the operating system installed on your computer.
    - Ensure that your computer meets the minimum hardware requirements needed to run the software. See the software documentation for information.
    - Ensure that the program is installed and configured properly.
    - Verify that the device drivers do not conflict with the program.
    - If necessary, uninstall and then reinstall the program.

# Using Support Tools

## Dell Support Center

The **Dell Support Center** helps you find the service, support, and system-specific information you need.

To launch the application, click the  icon in the taskbar.

The **Dell Support Center** home page displays your computer's model number, service tag, express service code, and service contact information.

The home page also provides links to access:

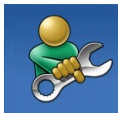

**Self Help** (Troubleshooting, Security, System Performance, Network/Internet, Backup/Recovery, and Windows operating system)



**Alerts** (technical support alerts relevant to your computer)



**Assistance from Dell** (Technical Support with DellConnect™, Customer Service, Training and Tutorials, How-To Help with Dell on Call, and Online Scan with PC CheckUp)



**About Your System** (System Documentation, Warranty Information, System Information, Upgrades & Accessories)

For more information about **Dell Support Center** and available support tools, click the **Services** tab at [support.dell.com](http://support.dell.com).

## System Messages

If your computer has an issue or error, it may display a System Message that will help you identify the cause and action needed to resolve the issue.

 **NOTE:** If the message you received is not listed in the following examples, see the documentation for either the operating system or the program that was running when the message appeared. Alternatively you could see the *Dell Technology Guide* available on your hard drive or at **support.dell.com** or see “Contacting Dell” on page 71 for assistance.

**Alert! Previous attempts at booting this system have failed at checkpoint [nnnn]. For help in resolving this problem, please note this checkpoint and contact Dell Technical Support** —

The computer failed to complete the boot routine three consecutive times for the same error. Contact Dell (see “Contacting Dell” on page 71).

**CMOS checksum error** — Possible motherboard failure or RTC battery low. Replace the battery (see the *Service Manual* at **support.dell.com/manuals**) or contact Dell (see “Contacting Dell” on page 71).

**CPU fan failure** — CPU fan has failed. Replace the CPU fan (see the *Service Manual* at **support.dell.com**).

## Using Support Tools

**Hard-disk drive failure** — Possible hard-disk drive failure during POST. Contact Dell (see “Contacting Dell” on page 71).

**Hard-disk drive read failure** — Possible hard-disk drive failure during HDD boot test. Contact Dell (see “Contacting Dell” on page 71).

**Keyboard failure** — Keyboard failure or loose cable.

To replace the keyboard (see the *Service Manual* at [support.dell.com](http://support.dell.com)).

**No boot device available** — No bootable partition on hard drive, the hard drive cable is loose, or no bootable device exists.

- If the hard drive is your boot device, ensure that the cables are connected and that the drive is installed properly and partitioned as a boot device.
- Enter system setup and ensure that the boot sequence information is correct (see the *Dell Technology Guide* available on your hard drive or at [support.dell.com](http://support.dell.com)).

**No timer tick interrupt** — A chip on the system board might be malfunctioning or there might be a system board failure (see “Contacting Dell” on page 71).

**USB over current error** — Disconnect the USB device. Your USB device needs more power for it to function properly. Use an external power source to connect the USB device, or if your device has two USB cables, connect both of them.

**CAUTION - Hard Drive SELF MONITORING SYSTEM has reported that a parameter has exceeded its normal operating range. Dell recommends that you back up your data regularly. A parameter out of range may or may not indicate a potential hard drive problem** — S.M.A.R.T error, possible hard drive failure. Contact Dell (see “Contacting Dell” on page 71).

## Hardware Troubleshooter

If a device is either not detected during the operating system setup or is detected but incorrectly configured, you can use the **Hardware Troubleshooter** to resolve the incompatibility.

To start the Hardware Troubleshooter:

1. Click **Start**  → **Help and Support**.
2. Type `hardware troubleshooter` in the search field and press <Enter> to start the search.
3. In the search results, select the option that best describes the problem and follow the remaining troubleshooting steps.

### Dell Diagnostics

If you experience a problem with your computer, perform the checks in “Lockups and Software Problems” on page 48 and run the Dell Diagnostics before you contact Dell for technical assistance.

It is recommended that you print these procedures before you begin.

 **NOTE:** Dell Diagnostics works only on Dell computers.

 **NOTE:** The *Drivers and Utilities* disc is optional and may not ship with your computer.

See the System Setup section in the *Service Manual* to review your computer’s configuration information, and ensure that the device that you want to test displays in the system setup program and is active.

Start the Dell Diagnostics from your hard drive or from the *Drivers and Utilities* disc.

### Starting Dell Diagnostics From Your Hard Drive

The Dell Diagnostics is located on a hidden diagnostic utility partition on your hard drive.

 **NOTE:** If your computer cannot display a screen image, contact Dell (see “Contacting Dell” on page 71).

1. Ensure that the computer is connected to an electrical outlet that is known to be working properly.
2. Turn on (or restart) your computer.
3. When the DELL™ logo appears, press <F12> immediately. Select **Diagnostics** from the boot menu and press <Enter>.

This may invoke the Pre-Boot System Assessment (PSA) on your computer.

 **NOTE:** If you wait too long and the operating system logo appears, continue to wait until you see the Microsoft® Windows® desktop; then, shut down your computer and try again.



 **NOTE:** If you see a message stating that no diagnostics utility partition has been found, run the Dell Diagnostics from the *Drivers and Utilities* disc.

*If PSA is invoked:*

- a. The PSA will start running tests.
- b. If the PSA completes successfully, the following message is displayed: `No problems have been found with this system so far. Do you want to run the remaining memory tests? This will take about 30 minutes or more. Do you want to continue? (Recommended).`

- c. If you are experiencing memory issues, press <y>, otherwise press <n>. The following message is displayed: `Booting Dell Diagnostic Utility Partition. Press any key to continue.`
- d. Press any key to go to the **Choose An Option** window.



*If PSA is not invoked:*

Press any key to start the Dell Diagnostics from the diagnostic utility partition on your hard drive and to go to the **Choose An Option** window.

## Using Support Tools

4. Select the test you want to run.
5. If a problem is encountered during a test, a message appears with an error code and a description of the problem. Write down the error code and problem description and contact Dell (see “Contacting Dell” on page 71).  
 **NOTE:** The Service Tag for your computer is displayed at the top of each test screen. If you contact Dell, technical support will ask for your Service Tag.
6. When the tests are complete, close the test screen to return to the **Choose An Option** window.
7. To exit the Dell Diagnostics and restart the computer, click **Exit**.

## Starting Dell Diagnostics From the Drivers and Utilities Disc

1. Insert the *Drivers and Utilities* disc.
2. Shut down and restart the computer. When the DELL logo appears, press <F12> immediately.  
 **NOTE:** If you wait too long and the operating system logo appears, continue to wait until you see the Microsoft® Windows® desktop; then, shut down your computer and try again.
-  **NOTE:** The next steps change the boot sequence for one time only. On the next start-up, the computer boots according to the devices specified in the system setup program.
3. When the boot device list appears, highlight **CD/DVD/CD-RW** and press <Enter>.

4. Select the **Boot from CD-ROM** option from the menu that appears and press <Enter>.
  5. Type 1 to start the CD menu and press <Enter> to proceed.
  6. Select **Run the 32 Bit Dell Diagnostics** from the numbered list. If multiple versions are listed, select the version appropriate for your computer.
  7. Select the test you want to run.
  8. If a problem is encountered during a test, a message appears with an error code and a description of the problem. Write down the error code and problem description and contact Dell (see “Contacting Dell” on page 71).
-  **NOTE:** The Service Tag for your computer is displayed at the top of each test screen. The Service Tag helps you identify your computer when you contact Dell.
9. When the tests are complete, close the test screen to return to the **Choose An Option** window.
  10. To exit the Dell Diagnostics and restart the computer, click **Exit**.
  11. Remove the *Drivers and Utilities* disc.

# Restoring Your Operating System

You can restore your operating system in the following ways:

- System Restore returns your computer to an earlier operating state without affecting data files. Use System Restore as the first solution for restoring your operating system and preserving data files.
- Dell Datasafe Local Backup returns your hard drive to either the operating state it was in when you purchased the computer or restores your operating system while preserving your data files. Use this option if System Restore did not resolve your problem.
- If you received an Operating System disc with your computer, you can use it to restore your operating system. However, using the Operating System disc also deletes all data on the hard drive. Use the disc only if System Restore did not resolve your operating system problem.

## System Restore

The Windows operating systems provide a System Restore option which allows you to return your computer to an earlier operating state (without affecting data files) if changes to the hardware, software, or other system settings have left the computer in an undesirable operating state. Any changes that System Restore makes to your computer are completely reversible.

 **CAUTION: Make regular backups of your data files. System Restore does not monitor your data files or recover them.**

 **NOTE:** The procedures in this document are applicable for the Windows default view, so they may not apply if you set your Dell™ computer to the Windows Classic view.

## Starting System Restore

1. Click **Start** .
2. In the **Start Search** box, type `System Restore` and press <Enter>.

 **NOTE:** The **User Account Control** window may appear. If you are an administrator on the computer, click **Continue**; otherwise, contact your administrator to continue the desired action.

3. Click **Next** and follow the instructions on the screen.

In the event that System Restore did not resolve the issue, you may undo the last system restore.

### Undoing the Last System Restore

 **NOTE:** Before you undo the last system restore, save and close all open files and exit any open programs. Do not alter, open, or delete any files or programs until the system restoration is complete.

1. Click **Start** .
2. In the **Start Search** box, type `System Restore` and press <Enter>.
3. Click **Undo my last restoration** and click **Next**.

### Dell DataSafe Local Backup

 **NOTE:** Dell DataSafe Local Backup may not be available in all regions.

Dell DataSafe Local Backup is a backup and recovery application that can restore your computer if you lose data due to a virus attack, accidentally delete critical files or folders, or if the hard drive crashes.

This application allows you to:

- Restore files and folders.
- Restore your hard drive to the operating state it was in when you purchased your computer, without erasing the existing personal files and data.

To schedule backups:

1. Double-click the Dell DataSafe Local icon  on the taskbar.
2. Choose **Full System Backup** to create and schedule automatic backup of all the data in your computer.

To restore data:

1. Turn off your computer.
2. Remove any recently added internal hardware and disconnect devices such as a USB drive, printer, and so on.

 **NOTE:** Do not disconnect the display, keyboard, mouse, and the power cable.

3. Turn on your computer.
4. When the DELL logo appears, press <F8> several times to access the **Advanced Boot Options** window.

 **NOTE:** If you wait too long and the operating system logo appears, continue to wait until you see the Microsoft® Windows® desktop; then, shut down your computer and try again.

5. Select **Repair Your Computer**.
6. Select **Dell Factory Image Recovery and DataSafe Options** and follow the instructions on the screen.

 **NOTE:** The duration of the restoration process depends on the amount of data to be restored.

 **NOTE:** For more information, see the knowledge base article 353560 at [support.dell.com](http://support.dell.com).

# Operating System Reinstallation

## Before You Begin

If you are considering reinstalling the Windows operating system to correct a problem with a newly installed driver, first try using Windows Device Driver Rollback.

To roll back a device driver:

1. Click **Start** .
2. Right-click **Computer**.
3. Click **Properties**→ **Device Manager**.
4. Right-click the device for which the new driver was installed, and click **Properties**.
5. Click the **Drivers** tab→ **Roll Back Driver**.

If Device Driver Rollback does not resolve the problem, then use System Restore to return your operating system to the operating state it was in before you installed the new device driver. See “System Restore” on page 59.

 **CAUTION:** Before performing the installation, back up all data files on your primary hard drive. For conventional hard drive configurations, the primary hard drive is the first drive detected by the computer.

To reinstall Windows, you need the following:

- Dell *Operating System* disc
- Dell *Drivers and Utilities* disc

 **NOTE:** The *Drivers and Utilities* disc contains drivers that were installed during the assembly of the computer. Use the Dell *Drivers and Utilities* disc to load any required drivers. Depending on the region from which you ordered your computer, or whether you requested the disc, the Dell *Drivers and Utilities* disc and *Operating System* disc may not ship with your computer.



## Reinstalling Microsoft Windows

The reinstallation process can take 1 to 2 hours to complete. After you reinstall the operating system, you must also reinstall the device drivers, virus protection program, and other software.

1. Save and close any open files and exit any open programs.
2. Insert the *Operating System* disc.
3. Click **Exit** if the **Install Windows** message appears.
4. Restart the computer.
5. When the DELL logo appears, press <F12> immediately.

 **NOTE:** If you wait too long and the operating system logo appears, continue to wait until you see the Microsoft® Windows® desktop; then, shut down your computer and try again.

 **NOTE:** The next steps change the boot sequence for one time only. On the next start-up, the computer boots according to the devices specified in the system setup program.

6. When the boot device list appears, highlight **CD/DVD/CD-RW Drive** and press <Enter>.
7. Press any key to **Boot from CD-ROM**. Follow the instructions on the screen to complete the installation.

# Getting Help

If you experience a problem with your computer, you can complete the following steps to diagnose and troubleshoot the problem:

1. See “Solving Problems” on page 44 for information and procedures that pertain to the problem your computer is experiencing.
2. See the *Dell Technology Guide* for more troubleshooting information.
3. See “Dell Diagnostics” on page 54 for procedures on how to run Dell Diagnostics.
4. Fill out the “Diagnostic Checklist” on page 70.
5. Use Dell’s extensive suite of online services available at Dell Support ([support.dell.com](http://support.dell.com)) for help with installation and troubleshooting procedures. See “Online Services” on page 66 for a more extensive list of Dell Support online.
6. If the preceding steps have not resolved the problem, see “Before You Call” on page 69.

 **NOTE:** Call Dell Support from a telephone near or at the computer so that the support staff can assist you with any necessary procedures.

 **NOTE:** Dell’s Express Service Code system may not be available in all countries.

When prompted by Dell’s automated telephone system, enter your Express Service Code to route the call directly to the proper support personnel. If you do not have an Express Service Code, open the **Dell Accessories** folder, double-click the **Express Service Code** icon, and follow the directions.

 **NOTE:** Some of the services are not always available in all locations outside the continental U.S. Call your local Dell representative for information on availability.

## Technical Support and Customer Service

Dell's support service is available to answer your questions about Dell hardware. Our support staff use computer-based diagnostics to provide fast, accurate answers.

To contact Dell's support service, see "Before You Call" on page 69 and then see the contact information for your region or go to **[support.dell.com](http://support.dell.com)**.

## DellConnect

DellConnect™ is a simple online access tool that allows a Dell service and support associate to access your computer through a broadband connection, diagnose your problem and repair it all under your supervision. For more information, go to **[www.dell.com/dellconnect](http://www.dell.com/dellconnect)**.

### Online Services

You can learn about Dell products and services on the following websites:

- **www.dell.com**
- **www.dell.com/ap** (Asian/Pacific countries only)
- **www.dell.com/jp** (Japan only)
- **www.euro.dell.com** (Europe only)
- **www.dell.com/la** (Latin American and Caribbean countries)
- **www.dell.ca** (Canada only)

You can access Dell Support through the following websites and e-mail addresses:

#### Dell Support websites

- **support.dell.com**
- **support.jp.dell.com** (Japan only)
- **support.euro.dell.com** (Europe only)
- **supportapj.dell.com** (Asia Pacific only)

#### Dell Support e-mail addresses

- **mobile\_support@us.dell.com**
- **support@us.dell.com**
- **la-techsupport@dell.com** (Latin America and Caribbean countries only)
- **apsupport@dell.com** (Asian/Pacific countries only)

#### Dell Marketing and Sales e-mail addresses

- **apmarketing@dell.com** (Asian/Pacific countries only)
- **sales\_canada@dell.com** (Canada only)

#### Anonymous file transfer protocol (FTP)

- **ftp.dell.com**  
Log in as user: `anonymous`, and use your e-mail address as your password.

## Automated Order-Status Service

To check on the status of any Dell products that you have ordered, you can go to **support.dell.com**, or you can call the automated order-status service. A recording prompts you for the information needed to locate and report on your order. For the telephone number to call your region, see “Contacting Dell” on page 71.

If you have a problem with your order, such as missing parts, wrong parts, or incorrect billing, contact Dell for customer assistance. Have your invoice or packing slip handy when you call. For the telephone number to call for your region, see “Contacting Dell” on page 71.

## Product Information



If you need information about additional products available from Dell, or if you would like to place an order, visit **www.dell.com**. For the telephone number to call for your region or to speak to a sales specialist, see “Contacting Dell” on page 71.

## Returning Items for Repair Under Warranty or for Credit

Prepare all items being returned, whether for repair or credit, as follows:

 **NOTE:** Before you return the product to Dell, make sure to back up any data on the hard drive(s) and on any other storage device in the product. Remove any and all confidential, proprietary and personal information, as well as removable media, such as CDs and ExpressCards. Dell is not responsible for any of your confidential, proprietary or personal information; lost or corrupted data; or damaged or lost removable media that may be included with your return.

1. Call Dell to obtain a Return Material Authorization Number, and write it clearly and prominently on the outside of the box. For the telephone number to call for your region, see “Contacting Dell” on page 71.

2. Include a copy of the invoice and a letter describing the reason for the return.
  3. Include a copy of the Diagnostics Checklist (see “Diagnostic Checklist” on page 70), indicating the tests that you have run and any error messages reported by the Dell Diagnostics (see “Dell Diagnostics” on page 54).
  4. Include any accessories that belong with the item(s) being returned (power cables, software, guides, and so on) if the return is for credit.
  5. Pack the equipment to be returned in the original (or equivalent) packing materials.
-  **NOTE:** You are responsible for paying shipping expenses. You are also responsible for insuring any product returned, and you assume the risk of loss during shipment to Dell. Collect On Delivery (C.O.D.) packages are not accepted.
-  **NOTE:** Returns that are missing any of the preceding requirements will be refused at Dell’s receiving dock and returned to you.

## Before You Call

**NOTE:** Have your Express Service Code ready when you call. The code helps Dell's automated-support telephone system direct your call more efficiently. You may also be asked for your Service Tag.

### Locating Your Service Tag

The Service Tag for your computer can be found on a label at the bottom of your computer.

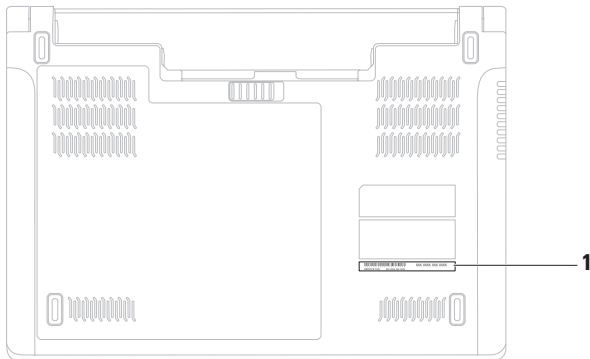

---

**1** Service tag

---

## Getting Help

Remember to fill out the following Diagnostics Checklist. If possible, turn on your computer before you call Dell for assistance and call from a telephone at or near the computer. You may be asked to type some commands at the keyboard, relay detailed information during operations, or try other troubleshooting steps possible only at the computer itself. Ensure that the computer documentation is available.

### **Diagnostic Checklist**

- Name:
- Date:
- Address:
- Phone number:
- Service Tag (bar code on the back or bottom of the computer):
- Express Service Code:
- Return Material Authorization Number (if provided by Dell support technician):
- Operating system and version:
- Devices:
- Expansion cards:
- Are you connected to a network? Yes/No
- Network, version, and network adapter:
- Programs and versions:



See your operating system documentation to determine the contents of the computer's start-up files. If the computer is connected to a printer, print each file. Otherwise, record the contents of each file before calling Dell.

- Error message, beep code, or diagnostic code:
- Description of problem and troubleshooting procedures you performed:

## Contacting Dell

For customers in the United States, call 800-WWW-DELL (800-999-3355).

 **NOTE:** If you do not have an active Internet connection, you can find contact information on your purchase invoice, packing slip, bill, or Dell product catalog.

Dell provides several online and telephone-based support and service options. Availability varies by country and product, and some services may not be available in your area.

To contact Dell for sales, technical support, or customer service issues:

1. Visit **[www.dell.com/contactdell](http://www.dell.com/contactdell)**.
2. Select your country or region.
3. Select the appropriate service or support link based on your requirement.
4. Choose the method of contacting Dell that is convenient for you.

# Finding More Information and Resources

**If you need to:**

---

reinstall your operating system

---

run a diagnostic program for your computer, reinstall laptop system software, or update drivers for your computer, and readme files

---

learn more about your operating system, maintaining peripherals, RAID, Internet, Bluetooth®, networking, and e-mail

---

upgrade your computer with new or additional memory, like a new hard drive

reinstall or replace a worn or defective part

---

**See:**

---

the *Operating System* disc

---

the *Drivers and Utilities* disc



**NOTE:** Drivers and documentation updates can be found at **support.dell.com**.

---

the *Dell Technology Guide* available on your hard drive or at **support.dell.com/manuals**.

---

the *Service Manual* at **support.dell.com/manuals**



**NOTE:** In some countries, opening and replacing parts of your computer may void your warranty. Check your warranty and return policies before working inside your computer.

---

**If you need to:**

find safety best practices information for your computer review Warranty information, Terms and Conditions (U.S. only), Safety instructions, Regulatory information, Ergonomics information, and End User License Agreement

find your Service tag/Express Service Code — You must use the service tag to identify your computer on **support.dell.com** or to contact technical support

find drivers and downloads

access technical support and product help

check on your order status for new purchases

find solutions and answers to common questions

locate information for last-minute updates about technical changes to your computer or advanced technical-reference material for technicians or experienced users.

**See:**



the safety and regulatory documents that shipped with your computer and also see the Regulatory Compliance Homepage at **www.dell.com/regulatory\_compliance**

the back or bottom of your computer the **Dell Support Center**. To launch the **Dell Support Center**, click the  icon in the taskbar.

**support.dell.com**

# Specifications

This section provides information that you may need when setting up, updating drivers for, and upgrading your computer.

 **NOTE:** Offerings may vary by region. For more information regarding the configuration of your computer, click **Start**  → **Help and Support** and select the option to view information about your computer.

System Model	Studio 1450	Studio 1457	Studio 1458
Computer Information			
System chipset	Intel GM45	Intel PM55	Intel HM55
Data bus width	64 bits		
Processor address bus width	32 bits		
DRAM bus width	dual channel (2) 64-bit buses	dual channel (2) 64-bit buses	dual channel (2) 64-bit buses
Flash EPROM	2 MB	4 MB	4 MB

<b>System Model</b>	<b>Studio 1450</b>	<b>Studio 1457</b>	<b>Studio 1458</b>
<b>Processor</b>			
Type	Intel® Core™2 Duo Intel Pentium® Dual-Core Intel Celeron® Dual-Core Intel Celeron	Intel® Core™ i7-720QM Intel Core i7-820QM	Intel® Core™ i7 Intel Core i5 Intel Core i3
L1 cache	64 KB (32 KB for each core)	256 KB (64 KB for each core)	128 KB (64 KB for each core)
L2 cache	2 MB, 3 MB, or 6 MB (Intel® Core™2 Duo) 1 MB (Intel Pentium® Dual-Core, Intel Celeron® Dual-Core, Intel Celeron)	1 MB (256 KB for each core)	512 KB (256 KB for each core)
L3 cache		upto 8 MB (6 MB/720 QM, 8 MB/820 QM)	up to 4 MB

## Specifications

### AC Adapter

---

65 W (E-Series) — Studio 1450 and 1458

#### Dimensions

Height 16 mm (0.6 inches)

Width 66 mm (2.6 inches)

Depth 127 mm (5.0 inches)

Weight (with cables) 0.29 kg (0.64 lb)

65 W (D-Series) — Studio 1450

#### Dimensions

Height 27.2 mm (1.0 inches)

Width 57.8 mm (2.2 inches)

Depth 137.2 mm (5.4 inches)

Weight (with cables) 0.36 kg (0.79 lb)

### AC Adapter

---

90 W (D-Series) — Studio 1450

#### Dimensions

Height 34.2 mm (1.3 inches)

Width 60.8 mm (2.3 inches)

Depth 153.4 mm (6.0 inches)

Weight (with cables) 0.46 kg (1.01 lb)

90 W (E-Series) — Studio 1450 and 1457

#### Dimensions

Height 16 mm (0.6 inches)

Width 70 mm (2.8 inches)

Depth 147 mm (5.8 inches)

Weight (with cables) 0.29 kg (0.64 lb)

**AC Adapter**

65 W (Auto Air Adapter) — Studio 1450, 1457, and 1458

## Dimensions

Height	15 mm (0.5 inches)
Width	66 mm (2.6 inches)
Depth	127 mm (5.0 inches)
Weight (without cables)	0.26 kg (0.57 lb)

**AC Adapter**

Input voltage	100–240 VAC
Input current	1.5 A
Input frequency	50–60 Hz
Output power	65 W or 90 W
Output current	
65W	4.34 A (maximum at 4-second pulse) 3.34 A (continuous)
90W	5.62 A (maximum at 4-second pulse) 4.62A (continuous)
Rated output voltage	19.5 +/- 1 VDC

## Specifications

### Memory

---

Connectors	two user-accessible SODIMM connectors
Type	1067 MHz SODIMM DDR3 (Studio 1450) 1333 MHz SODIMM DDR3 (Studio 1457) 1066 MHz SODIMM DDR3 (Studio 1458)
Capacities	1 GB, 2 GB, 3 GB, 4 GB, 5 GB, 6 GB, and 8 GB
Minimum	1 GB (single channel)
Maximum	8 GB (dual channel)

### Express Card

---

Cards supported	ExpressCard/34 (34 mm) 1.5 V and 3.3 V
Connector size	26 pins
Controller	Intel ICH9M (Studio 1450) Intel PM55 (Studio 1457) Intel HM55 (Studio 1458)



**Media**

---

Drive	CD/DVD writer (Dual Layer DVD+/-RW Drive) Blu-ray Disc™ (optional)
-------	---

**8-in-1 Memory Card Reader**

---

Card controller	Realtek RTS5159
Card connector	8-in-1 combo single slot

**Communications**

---

Modem (optional)	External V.92 56K USB modem
Modem controller	Hardware modem
Modem interface	Universal Serial Bus (USB)
Network adapter	10/100/1000 Ethernet LAN on system board
Wireless	WPAN with Bluetooth® wireless technology, internal WWAN, and WLAN with WiFi bgn

## Specifications

### Video

---

TV support	HDMI 1.2 (Studio 1450)  HDMI 1.3 (Studio 1457 and 1458)
LCD interface	Low Voltage Differential Signaling (LVDS)
Discrete	
Video Type	Integrated on system board
Video controller	ATI Mobility Radeon HD 4530  ATI Mobility Radeon HD 5450
Video memory	256/512/1024 MB GDDR3 technology

### Video

---

UMA	
Video type	Integrated on system board (Studio 1450 and 1458)
Video controller	Integrated GMA 4500MHD (Studio 1450)  Intel® GMA HD (Studio 1458)
Video memory	Up to 358 MB of shared memory (Studio 1450)  Up to 1.7 GB of shared memory (Studio 1458)

**Audio**

Audio type	5.1 channel High Definition Audio with SRS Premium Sound™
Audio controller	Realtek ALC665 High Definition Audio codec
Stereo conversion	24-bit (analog-to-digital and digital-to-analog)
Internal interface	Intel High Definition Audio
Speaker	two 6-ohm speakers
Volume controls	software program menus or multimedia keys

**Connectors**

Audio	one microphone connector, two stereo headphone/speaker connectors
Mini-Card	one full Mini-Card and one half Mini-Card slots
Network adapter	RJ45 connector
eSATA	one seven-pin/ four-pin eSATA/USB combo connector
USB	two 4-pin USB 2.0-compliant connectors
HDMI	one 19-pin connector
VGA	one 15-pin connector

## Specifications

### Display

---

Type	14.0 inch HD with TrueLife LED 14.0 inch HD+ with TrueLife LED
Dimensions:	
Height	173.95 mm (6.85 inches)
Width	309.4 mm (12.2 inches)
Diagonal	356 mm (14.0 inches)
Maximum resolution:	
HD with TrueLife	1366 x 768
HD+ with TrueLife	1600 x 900
Refresh rate	60 Hz
Operating angle	0° (closed) to 140°

### Display

---

Viewing angles:	
Horizontal	±40° (HD and HD+ with TrueLife)
Vertical	+15°/-30° (HD and HD+ with TrueLife)
Pixel pitch:	
HD with TrueLife	0.2265 mm
HD+ with TrueLife	0.1935 mm
Controls	brightness can be controlled through keyboard shortcuts (see the <i>Dell Technology Guide</i> for more information)

**Keyboard (Backlit)**

---

Number of keys	86 (U.S. and Canada); 87 (Europe); 90 (Japan); 87 (Brazil)
Layout	QWERTY/AZERTY/Kanji

**Camera**

---

Pixel	2.0 megapixel
Video resolution	320 x 240 ~1280 x 1024 (640 x 480 at 30 fps)
Diagonal viewing angle	66°

**Touch Pad**

---

X/Y position resolution (graphics table mode)	240 cpi
Size	
Width	81.0 mm (3.19 inches) sensor-active area
Height	42.0 mm (1.65 inches) rectangle

## Specifications

### Battery

---

Type	6-cell/9-cell smart lithium ion
Depth	60.4 mm (2.38 inches)
Height	20.3 mm (0.80 inches) (6-cell) 39.2 mm (1.54 inches) (9-cell)
Width	273 mm (10.7 inches)
Weight	0.33 kg (0.72 lb) (6-cell) 0.48 kg (1.05 lb) (9-cell)
Voltage	11.1 VDC (6/9-cell)
Charge time (approximate)	4 hours (when the computer is turned off)

### Battery

---

Operating time	Varies depending on operating conditions and can be significantly reduced under certain power-intensive conditions.  See the <i>Dell Technology Guide</i> for more information
Life span (approximate)	300 discharge/charge cycles
Temperature range:	
Operating	0° to 35°C (32° to 95°F)
Storage	-40° to 65°C (-40° to 149°F)
Coin-cell battery	CR-2032

**Physical**

---

Height	24.8 mm to 38.6 mm (0.98 inches to 1.52 inches)
Width	240.0 mm (9.44 inches)
Depth	336 mm (13.23 inches)
Weight (with 6-cell battery) configurable to less than	2.38 kg (5.25 lb)

**Computer Environment**

---

Relative humidity (maximum):	
Operating	10% to 90% (noncondensing)
Storage	5% to 95% (noncondensing)
Altitude (maximum):	
Operating	-15.2 to 3048 m (-50 to 10,000 ft)
Storage	-15.2 to 10,668 m (-50 to 35,000 ft)
Airborne contaminant level	G2 or lower as defined by ISA-S71.04-1985

## Specifications

### Computer Environment

---

Temperature range:

Operating                      0° to 35°C (32° to 95°F)

Storage                         -40° to 65°C  
                                      (-40° to 149°F)

Maximum vibration (using a random-vibration spectrum that simulates user environment):

Operating                      0.66 GRMS

Non-Operating                1.30 GRMS

### Computer Environment

---

Maximum shock (for operating – measured with Dell Diagnostics running on the hard drive and a 2-ms half-sine pulse; for non-operating – measured with hard drive in head-parked position and a 2-ms half-sine pulse):

Operating                      110 GRMS

Non-Operating                160 GRMS



# Appendix

## Information for NOM, or Official Mexican Standard (only for Mexico)

The following information is provided in the device(s) described in this document in accordance with the requirements of the Official Mexican Standard (NOM):

### Importer:

Dell México S.A. de C.V.  
Paseo de la Reforma 2620 – Flat 11°  
Col. Lomas Altas  
11950 México, D.F.

### Laptops

Regulatory model number	Voltage	Frequency	Electricity consumption	Output intensity
P03G	100-240 VAC	50-60 Hz	1.5 A	3.34 A/4.62 A

For details, read the safety information that shipped with your computer.

For additional safety best practices information, see the Regulatory Compliance Homepage at [www.dell.com/regulatory\\_compliance](http://www.dell.com/regulatory_compliance).

# Index

## A

airflow, allowing **5**

## B

backups

    creating **42**

## C

calling Dell **69**

CDs, playing and creating **39**

computer capabilities **39**

computer, setting up **5**

Contacting Dell online **71**

customer service **65**

customizing

    your desktop **39**

## D

damage, avoiding **5**

data, backing up **41**

DataSafe Local Backup **60**

DellConnect **65**

Dell Diagnostics **54**

Dell Support Center **50**

Dell Technology Guide

    for further information **72**

Diagnostic Checklist **70**

disc drive

    supported disc sizes **38**

discs

    ejecting **38**

    using **38**

drivers and downloads **73**

DVDs, playing and creating **39**

## **E**

e-mail addresses

    for technical support **66**

expansion bus **79**

## **F**

finding more information **72**

FTP login, anonymous **66**

## **H**

hardware problems

    diagnosing **53**

Hardware Troubleshooter **53**

help

    getting assistance and support **64**

## **I**

Internet connection **14**

ISP

    Internet Service Provider **14**

## **M**

memory problems

    solving **47**

## **N**

network connection

    fixing **45**

network speed

    testing **45**

## **P**

power problems, solving **46**

power strips, using **6**

## Index

problems, solving **44**

products

information and purchasing **67**

## R

reinstalling Windows **58**

resources, finding more **72**

restoring data **61**

## S

setup, before you begin **5**

shipping products

for return or repair **68**

SIM **10**

software features **39**

software problems **48**

solving problems **44**

specifications **74**

support e-mail addresses **66**

support sites

worldwide **66**

System Messages **51**

System Restore **58**

## U

USB PowerShare **24**

## V

ventilation, ensuring **5**

## W

warranty returns **68**

Windows, reinstalling **58**

Windows Vista®

Program Compatibility Wizard **48**

reinstalling **63**

wireless network connection **45**





Printed in the U.S.A.

[www.dell.com](http://www.dell.com) | [support.dell.com](http://support.dell.com)



OKWJH0A01